

KGZ



Strong, precise, and reliable cut-off performance

Provides stable machining
and is easy to use with
unique clamp design

New coating PR20 series
provides longer tool life

Extensive product line-up
for a wide variety
of applications.



**KEEPS YOU
AHEAD**



Cut-off solutions for small parts machining

KGZ

Provides stable machining and is easy to use with unique clamp design.
New coating PR20 series provides longer tool life and supports a wide range of applications.

Challenge

Cut-off is an important, but difficult process in small parts machining applications

Machining performance

High machining load and tool rigidity issues.
Chatter / Insert and holder damage / Difficulty improving machining efficiency etc.

Usability

Inserts can be difficult to replace inside the machine resulting in time-consuming work and the possibility of insecure clamping.

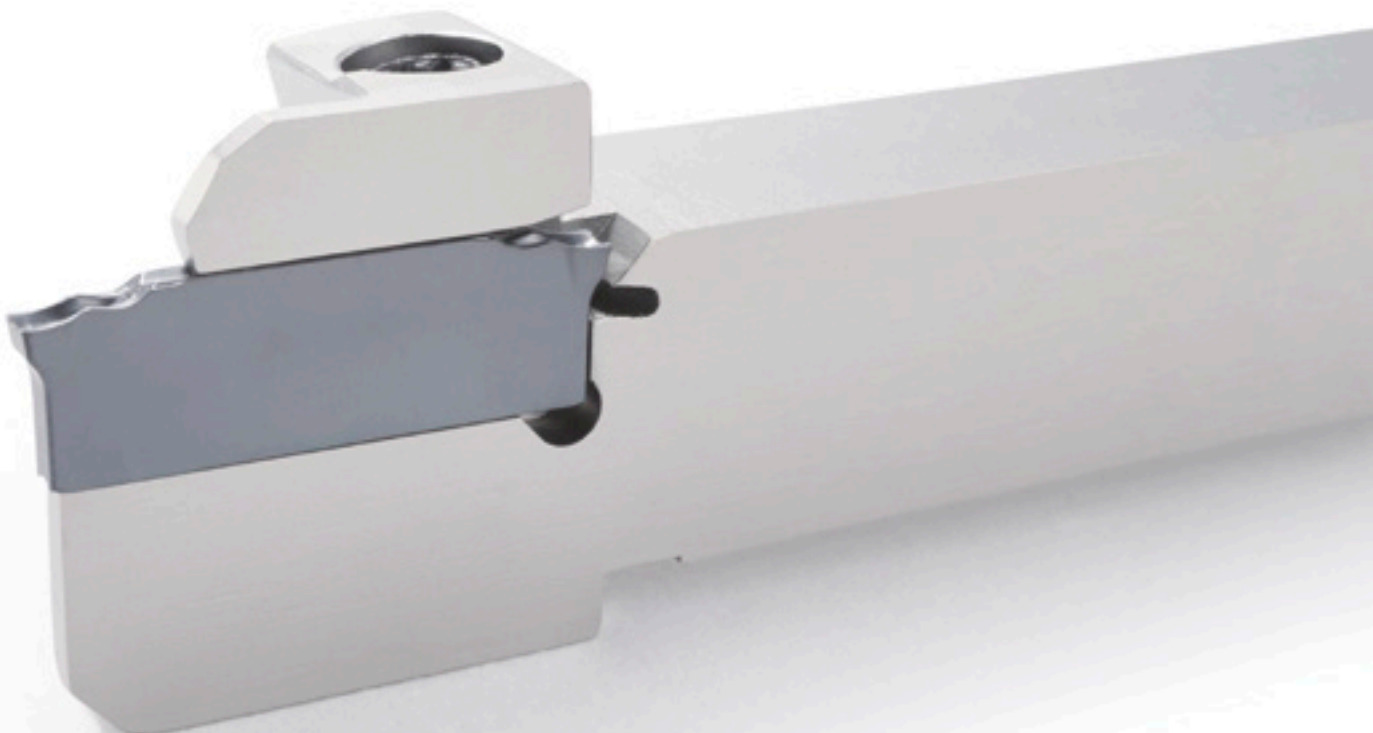

Newly developed clamp creates a strong and rigid hold

Strength

Stable machining
with sturdy clamp design





- Greater chatter resistance provides excellent surface finish and stable tool life
- Toolholder durability reduces down-time and cuts cost
- Supports high efficiency machining and reduces cycle time.

Dependability

Easy insert management

- Fast and secure insert installation
- Inserts are more resistant to wear and reduce the frequency of tool changes.



Insert CW: 1.3 ~ 3 mm	Low feed PF 	Medium feed PM 	High feed PH 	Low cutting force PG 	PVD coating P M K PR2015 / PR2025 / PR2035 NEW
	DLC coating N Non-coated carbide K N PDL025 GW15				
Toolholder 1010 ~ 2525	Internal coolant JCTM Series for direct coolant.		External coolant Standard type / For sub-spindle tooling.		

1 Achieved stable machining with newly developed clamp structure

Toolholder Sturdy clamps

Three unique features

Strength

1. Gap section
Tapered slit

2. Top clamp
Pulls insert down and back

3. Stopper
Obtuse angle stopper

Cutting edge movement comparison
(Internal evaluation)

Load (N)	KGZ (mm)	Competitor A (mm)
0	0.00	0.00
40	~0.02	~0.04
80	~0.04	~0.08
120	~0.06	~0.12
160	~0.08	~0.16

Amount of movement (mm)

Load (N)

KGZR1212JX-2

1. Gab section Tapered slit creates strong insert hold.

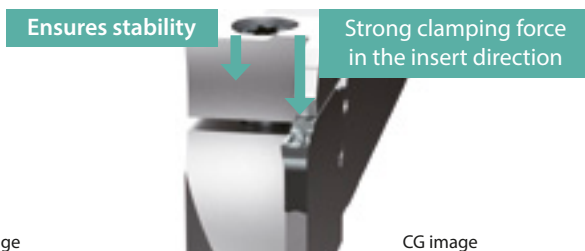
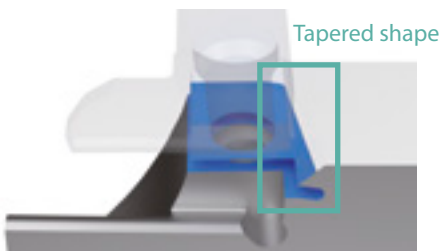

2. Top clamp Pulls insert inward to increase hold.



3. Stopper The insert stop is designed with an obtuse shape to resist machining load and a large surface area distributes stress. Improved holder durability for high-efficiency machining.

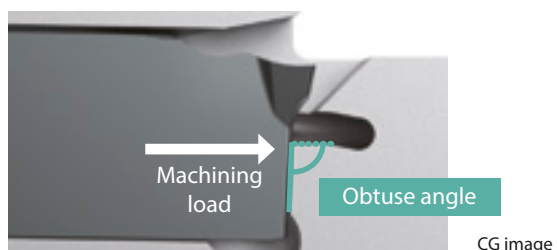

Insert Ease insert installation

Top V-shape

Different groove angles at ends end centre

Groove end

Small groove angle on top of insert.
These grooves prevent the insert from shifting and provide fast and accurate insert mounts.

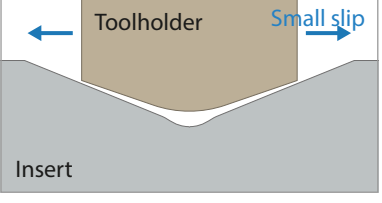

Image

Centre of groove

Large groove angle on top of insert.
Firmly engages the toolholder to increase hold.

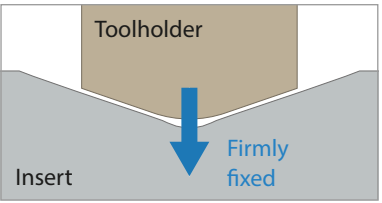

Image

Dependability

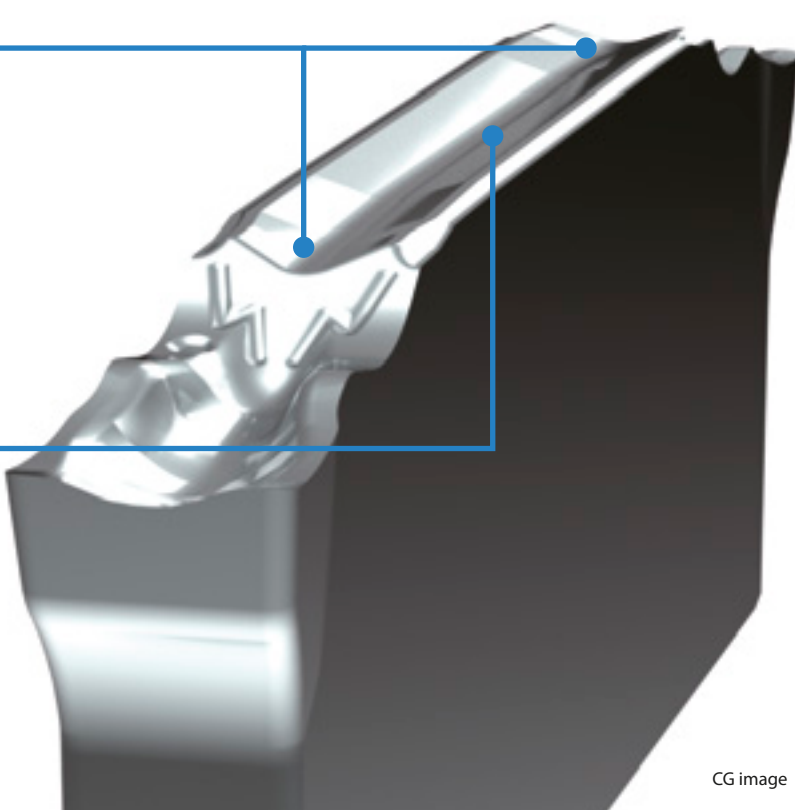

CG image

Excellent chatter resistance

Machined surface comparison (Internal evaluation)

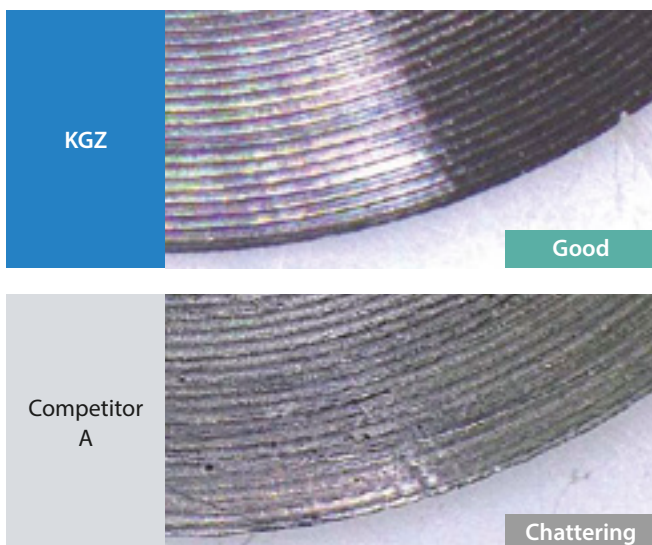



Cutting conditions: $V_c = \sim 60$ m/min., $f = 0.12$ mm/rev.
Workpiece: SUS303 ($\phi 14$). Wet (External coolant). KGZR1212JX-2.
Edge width: 2 mm (PM chipbreaker).

Strong toolholder durability



Toolholder durability comparison (Internal evaluation)

Toolholder damage comparison after 100,000 cuts

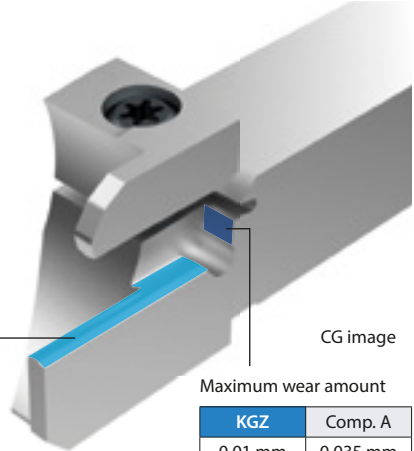
Maximum wear amount	KGZ	Comp. A
	0.015 mm	0.02 mm
		



CG image

Maximum wear amount	KGZ	Comp. A
	0.01 mm	0.035 mm
		

Cutting conditions: $V_c = \sim 80$ m/min., $f = 0.1$ mm/rev.
Workpiece: SUS303 ($\phi 14$). Wet (External coolant). KGZR1212JX-2.
Edge width: 2 mm (PM chipbreaker).

2

New insert grades PR20 series is available MEGACOAT NANO EX coating technology provides longer tool life

New insert grades for grooving and cut-off solutions

PR20 Series NEW

PR2015

1st recommendation for cast iron
Also available for steel and stainless steel.

PR2025

1st recommendation for steel
Also available for stainless steel.

PR2035

1st recommendation for stainless steel
Also available for steel.

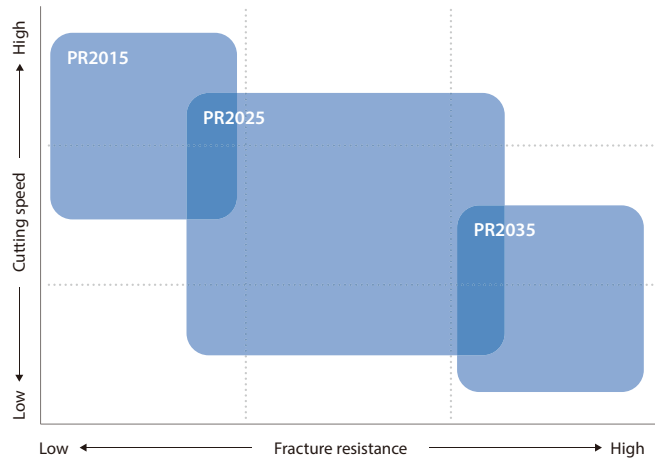

New coating for grooving and cut-off machining



Achieve long tool life and high stability with the combination of high content aluminium nano coating layer.

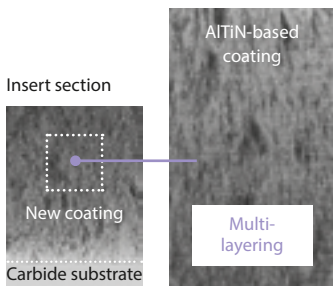

Special nano coating layer

Long tool life Excellent wear and fracture resistance

Multi-layering of high content aluminium nano layers added with high melting point material having different concentration. Suppresses hexagonal crystal precipitation and achieves excellent oxidation resistance.

Stable machining High coating toughness

Crystal grain refinement.
Optimised internal stress suppresses crack growth.

Coating characteristics (Internal evaluation)

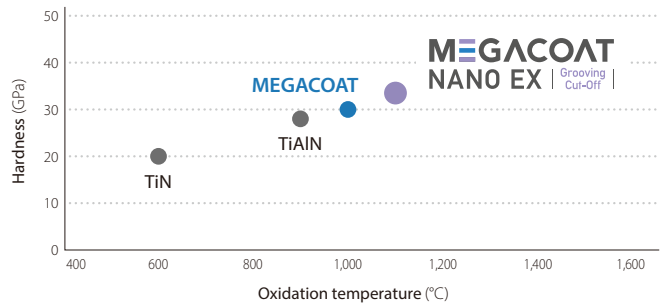

Unique technology (Patent applied)

Proprietary coating process
Improve high content aluminium nano layers performance.

Maintains a cubic crystal structure to maximize the properties of aluminium (Al)

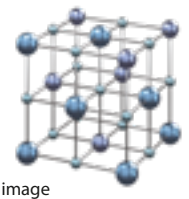

Cutting performance

S45C wear resistance comparison (Internal evaluation)

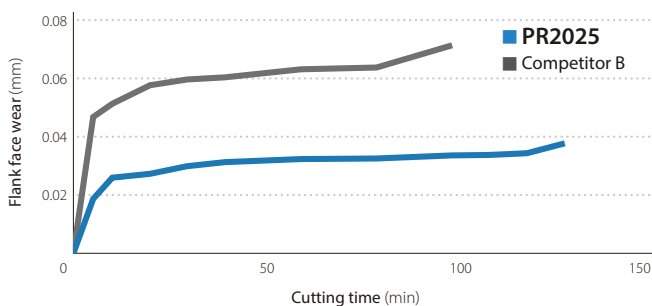

Cutting conditions : $V_c \sim 100$ m/min., $f = 0.1$ mm/rev
Workpiece : S45C ($\varnothing 20$) Wet (External coolant) GZM2020N-020PM



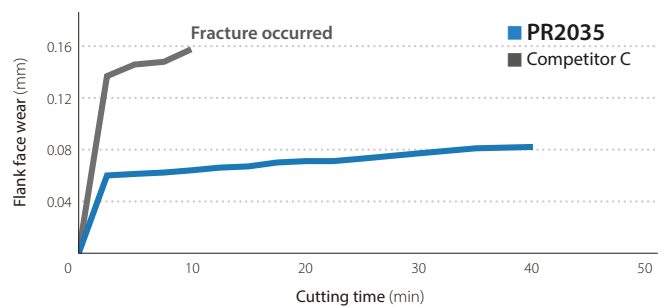



SUS304 wear resistance comparison (Internal evaluation)

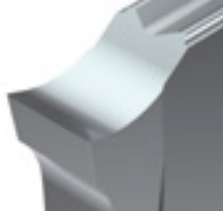

Cutting conditions : $V_c \sim 80$ m/min., $f = 0.05$ mm/rev
Workpiece : SUS304 ($\varnothing 20$) Wet (External coolant) GZM2020N-020PM

3

Choose from a variety of insert and chipbreaker combinations for a wide range of applications

	Chip control oriented			Sharp edge
Chipbreakers	<p>Low feed machining PF chipbreaker</p>  <p>With/without lead angle</p>	<p>Medium feed machining PM chipbreaker</p>  <p>With/without lead angle</p>	<p>High feed machining PH chipbreaker</p>  <p>No lead angle</p>	<p>Low cutting force PG chipbreaker</p>  <p>With/without lead angle</p>
Grades	<ul style="list-style-type: none"> PR2015 PR2025 PR2035 	<ul style="list-style-type: none"> PR2015 PR2025 PR2035 	<ul style="list-style-type: none"> PR2015 PR2025 PR2035 	<ul style="list-style-type: none"> PR2025 PR2035 PDL025 GW15
Features	<p>Edge width from 1.3 mm. For reducing cost of steel workpiece.</p>  <p>S10C »Chip control« video</p>	<p>High versatility. For a variety of machining.</p>  <p>SUS304 »Chip control« video</p>	<p>Reduced cycle time. For high feed machining.</p>  <p>S45C »Chip control« video</p>	<p>Superior sharpness. For aluminium alloy machining.</p>  <p>A6061 »Chip control« video</p>

Solution

High efficiency machining with PH chipbreaker

Supports high feed machining with $f = \sim 0.2$ mm/rev (steel) and $f = \sim 0.16$ mm/rev (stainless steel). Excellent chip control in a wide range of machining area.

S45C chip control comparison (Internal evaluation)

f (mm/rev)	0.1	0.15	0.2
KGZ PH			
Competitor D	 Entanglement		
Competitor E			 Unstable

Cutting conditions: $V_c = \sim 150$ m/min. Workpiece: S45C ($\varnothing 14$). Wet (External coolant). KGZR1616JX-2. Edge width: 2 mm (PH chipbreaker).

SUS304 chip control comparison (Internal evaluation)

f (mm/rev)	0.1	0.12	0.16
KGZ PH			
Competitor D		 Entanglement	
Competitor E			 Unstable

Cutting conditions: $V_c = \sim 80$ m/min. Workpiece: SUS304 ($\varnothing 14$). Wet (External coolant). KGZR1616JX-2. Edge width: 2 mm (PH chipbreaker).

4

Supports vibration/oscillation machining with stable chipcontrol and longer tool life

Stable machining

Breaks chips into small pieces with vibration machining

SUS304 chip control comparison (Internal evaluation)

PF chipbreaker



Good

Breaks chips into small pieces

Cutting conditions : $V_c = \sim 120$ m/min., $f = 0.03$ mm/rev.
Workpiece: SUS304 ($\varnothing 14$). Wet (External coolant). KGZR1212JX-2. Edge width: 2 mm.

PM chipbreaker



Good

Breaks chips into small pieces

Cutting conditions : $V_c = \sim 120$ m/min., $f = 0.05$ mm/rev.
Workpiece: SUS304 ($\varnothing 14$). Wet (External coolant). KGZR1616JX-2. Edge width: 2 mm.

Long tool life

Extended tool life in combination with internal coolant (JCTM)

Wear resistance comparison (Internal evaluation)

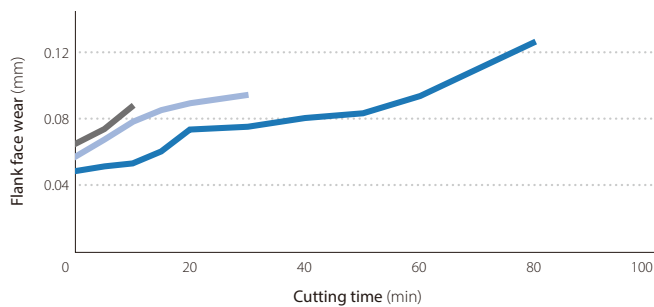

Cutting edge condition

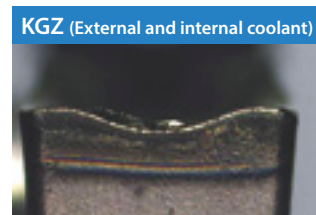

After 40 minutes machining.



After 15 minutes machining.

Cutting conditions: $V_c = \sim 120$ m/min., $f = 0.05$ mm/rev. Workpiece: SUS304 ($\varnothing 14$). Wet. KGZR1218JX-2JCTM. Edge width: 2 mm. (PM chipbreaker).

Direct coolant holder for small parts machining

JCTM Series

Long tool life and stable machining by internal coolant with/without piping system.

Rectangular shank with optimised coolant channel design.

1st recommendation

Square shank is also available.

Without piping

When the tool turret supports direct coolant

- Coolant is supplied directly from tool turret into the holder.
- No need for piping just by installing tools.

With piping

- Compatible with internal coolant on any machine with standard piping parts.

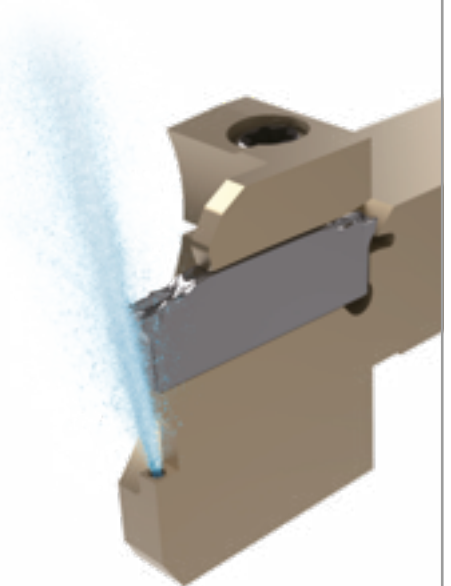

CG image



1 Pin SUS304



Cutting conditions
 $V_c \sim 36$ m/min.
 $f = 0.02$ mm/rev
 Wet (External coolant)
 $\varnothing 15$
 KGZL1616JX-2
 GZM2020N-020PM (PR2035)

Number of parts

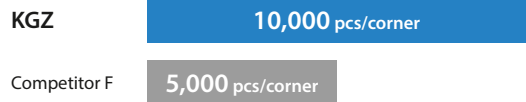

Tool life
 2x

Tool life was extended in stainless steel machining. Machining surface quality and chip control were good. (User evaluation)

2 Base metal S45C



Cutting conditions (KGZ)
 $V_c \sim 104$ m/min., $f = 0.02 \sim 0.05$ mm/rev
 Wet (External coolant) $\varnothing 9.7$
 Edge width : 2 mm
 KGZL1212JX-2
 GZM2020N-020PM (PR2025)
 Cutting conditions (Competitor G)
 $V_c \sim 86$ m/min., $f = 0.02 \sim 0.05$ mm/rev
 Wet (External coolant) $\varnothing 9.7$
 Edge width: 2 mm

Machining efficiency

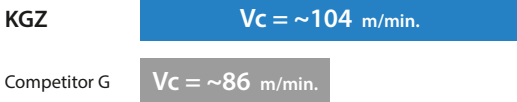

Machining efficiency
 UP

KGZ machined the workpieces equivalent to competitor G with higher cutting speed. The cutting edge was good. (User evaluation)

3 Automotive parts SUS304F



Cutting conditions
 $V_c \sim 108$ m/min.
 $f = 0.12$ mm/rev
 Wet (External coolant)
 $\varnothing 15.2$
 KGZR1212JX-2
 GZM2020N-020PM (PR2035)

Number of parts

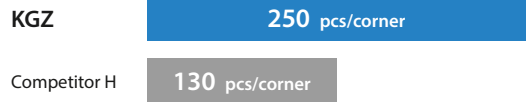

Tool life
 1.9x

Competitor H had welding. KGZ had no welding and good chip control. Achieved about 1.9 times longer tool life. (User evaluation)

4 Wedge S48C



Cutting conditions
 $n = 2,100$ min⁻¹ (Constant)
 $f = 0.12$ mm/rev
 Wet (External coolant)
 $\varnothing 20$
 KGZR1616JX-3
 GZM3020N-025PM (PR2015)

Number of parts

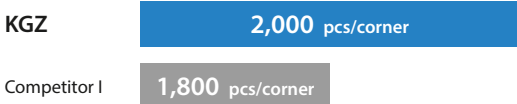

Tool life
 1.1x

Longer tool life under high feed conditions ($f = 0.12$ mm/rev). (User evaluation)

5 Sleeve 12Cr







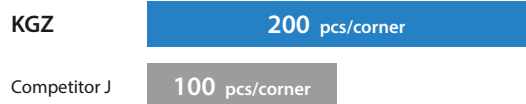

Cutting conditions
 $V_c \sim 72$ m/min.
 $f = 0.08$ mm/rev
 Wet (External coolant)
 $\varnothing 65$
 KGZR2020JX-3D42
 GZM3020N-025PM (PR2025)

Number of parts



Tool life
 2x

Stable machining was possible even with hollow workpiece. Double the tool life. (User evaluation)

Shape Handed insert shows Right-hand	Description	No. of corners	Dimensions (mm)				Angle	MEGACOAT NANO EX		DLC coating	Carbide	Applicable toolholders																																				
			CW	S	RE	INSL		PSIR °/L	PR2015				PR2025																																			
														Tolerance																																		
Low feed	 GZM 1316N-003PF 1316N-015PF 1516N-003PF 1516N-015PF	1.3	+0.04 -0.04	4.4	16	-	●	●	●			KGZ R/L...1.3(D16) KGZS R/L...1.3A/B																																				
													1.5	0.03	●	●	●			KGZ R/L...1.5(D16) KGZS R/L...1.5A/B																												
														0.15	●	●	●																															
													15° Lead angle	 GZM 1316R-003PF-15D 1316L-003PF-15D 1516R-003PF-15D 1516L-003PF-15D 1516R-015PF-15D	1.3	4.4	16	15°	●	●	●			KGZ R/L...1.3(D16) KGZS R/L...1.3A/B																								
	1.5	0.03										●													●	●			KGZ R/L...1.5(D16) KGZS R/L...1.5A/B																			
		1.5										0.15			●									●	●																							
	 GZM 2020N-003PF 2020N-015PF 2520N-003PF 2520N-015PF 3020N-003PF 3020N-015PF											2			+0.04 -0.04									5.9	20	-	●	●	●			KGZ R/L...-2(...) KGZS R/L...-2A/B																
		2.5											0.03	●																			●	●			KGZ R/L...-2(...) KGZ R/L...-2.4(...) KGZS R/L...-2A/B											
												3	0.03	●																		●	●			KGZ R/L...-2(...) KGZ R/L...-2.4(...) KGZ R/L...-3(...) KGZS R/L...-2A/B												
		3											0.15	●																		●	●															
												15° Lead angle	 GZM 2020R-003PF-15D 2020L-003PF-15D 2020R-015PF-15D 2520R-003PF-15D 2520L-003PF-15D 2520R-015PF-15D 3020R-003PF-15D 3020L-003PF-15D 3020R-015PF-15D	2																		+0.04 -0.04	5.9	20	15°	●	●	●			KGZ R/L...-2(...) KGZS R/L...-2A/B							
		2.5																																								0.03	●	●	●			KGZ R/L...-2(...) KGZ R/L...-2.4(...) KGZS R/L...-2A/B
	3													0.03																											●	●	●			KGZ R/L...-2(...) KGZ R/L...-2.4(...) KGZ R/L...-3(...) KGZS R/L...-2A/B		
		3												0.15																											●	●	●					
	Medium feed													 GZM 2020N-020PM 2520N-020PM 3020N-025PM																											2	+0.03 -0.03	5.9	20	-	●	●	●
2.5		0.2	●	●	●			KGZ R/L...-2(...) KGZ R/L...-2.4(...) KGZS R/L...-2A/B																																								
		3	0.25	●	●	●			KGZ R/L...-2(...) KGZ R/L...-3(...) KGZS R/L...-2A/B																																							
6° Lead angle			 GZM 2020R-020PM-6D 2520R-020PM-6D 3020R-025PM-6D	2	+0.03 -0.03	5.9	20	6°	●	●	●																																					
		2.5										0.2	●			●	●			KGZ R/L...-2(...) KGZ R/L...-2.4(...) KGZS R/L...-2A/B																												
				3								0.25	●			●	●			KGZ R/L...-2(...) KGZ R/L...-3(...) KGZS R/L...-2A/B																												

Using PF or PM chipbreaker for grooving will not create a flat bottom.
GZM and GZG inserts cannot be installed in KGM and KGD holders.

●: Available

Shape Handed insert shows Right-hand	Description	No. of corners	Dimensions (mm)					Angle	MEGACOAT NANO EX		DLC coating	Carbide	Applicable toolholders			
			CW Tolerance	S	RE	INSL	PSIR R/L		PR2015	PR2025				PR2035	PDL025	GW15
									PR2015	PR2025				PR2035	PDL025	GW15
High feed	GZM 2020N-020PH	2	+0.03 -0.03	5.9	0.2	20	-	●	●	●		KGZ R/L...-2(...) KGZS R/L...-2A/B				
	2520N-020PH	2						2.5	●	●	●		KGZ R/L...-2(...) KGZ R/L...-2.4(...) KGZS R/L...-2A/B			
	3020N-030PH	3						0.3	●	●	●		KGZ R/L...-2(...) KGZ R/L...-2.4(...) KGZ R/L...-3(...) KGZS R/L...-2A/B			
	GZMS 2020N-020PH	1						2	0.2	●	●	●		KGZ R/L...-2(...) KGZS R/L...-2A/B		
	3020N-030PH	3						0.3	●	●	●		KGZ R/L...-2(...) KGZ R/L...-2.4(...) KGZ R/L...-3(...) KGZS R/L...-2A/B			
	GZG 2020N-005PG	2						+0.02 -0.02	5.9	0.05	20	-	●	●	●	●
2520N-005PG	2	2.5	●	●	●	●	KGZ R/L...-2(...) KGZ R/L...-2.4(...) KGZS R/L...-2A/B									
3020N-005PG	3	0.3	●	●	●	●	KGZ R/L...-2(...) KGZ R/L...-2.4(...) KGZ R/L...-3(...) KGZS R/L...-2A/B									
GZG 2020R-005PG-15D	2	2	●	●	●	●	KGZ R/L...-2(...) KGZS R/L...-2A/B									
2520R-005PG-15D	2	2.5	●	●	●	●	KGZ R/L...-2(...) KGZ R/L...-2.4(...) KGZS R/L...-2A/B									
3020R-005PG-15D	3	0.3	●	●	●	●	KGZ R/L...-2(...) KGZ R/L...-2.4(...) KGZ R/L...-3(...) KGZS R/L...-2A/B									

●: Available

Inserts identification system

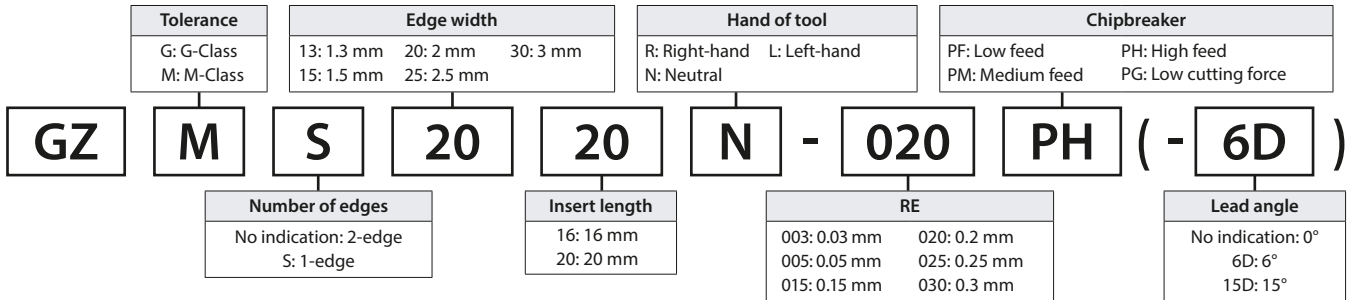

Recommended cutting conditions ★ 1st recommendation ☆ 2nd recommendation

Workpiece	Vc (m/min)					f (mm/rev)										Remarks
	MEGACOAT NANO EX			DLC	Carbide	PF (RE = 0.03)		PF (RE = 0.15)			PM	PH	PG			
	PR2015	PR2025	PR2035	PDL025	GW15	1.3~1.5	2.0	2.5~3.0	1.3~1.5	2.0	2.5~3.0	2.0~3.0	2.0~3.0	2.0	2.5~3.0	
Carbon steel	★ 70~180	★ 70~150	☆ 70~150	-	-	0.01~0.04	0.02~0.06	0.02~0.08	0.01~0.05	0.03~0.08	0.04~0.10	0.05~0.15	0.10~0.20	0.01~0.04	0.01~0.05	
Alloy steel	☆ 70~180	★ 70~150	☆ 70~150	-	-	0.01~0.03	0.01~0.04	0.01~0.05	0.01~0.04	0.03~0.07	0.04~0.08	0.04~0.12	0.08~0.16	0.01~0.03	0.01~0.04	
Stainless steel	☆ 60~150	☆ 60~120	★ 60~120	-	-	0.01~0.05	0.02~0.07	0.03~0.08	0.01~0.06	0.03~0.09	0.04~0.10	0.05~0.15	0.10~0.20	0.01~0.04	0.01~0.05	
Cast iron	★ 80~200	-	-	-	☆ 50~100	-	-	-	-	-	-	-	-	0.01~0.05	0.01~0.06	
Aluminum alloy	-	-	-	★ 200~500	☆ 200~450	-	-	-	-	-	-	-	-	0.01~0.07	0.01~0.08	
Brass	-	-	-	-	★ 100~200	-	-	-	-	-	-	-	-	0.01~0.07	0.01~0.08	

KGZ-JCTM (Internal coolant)

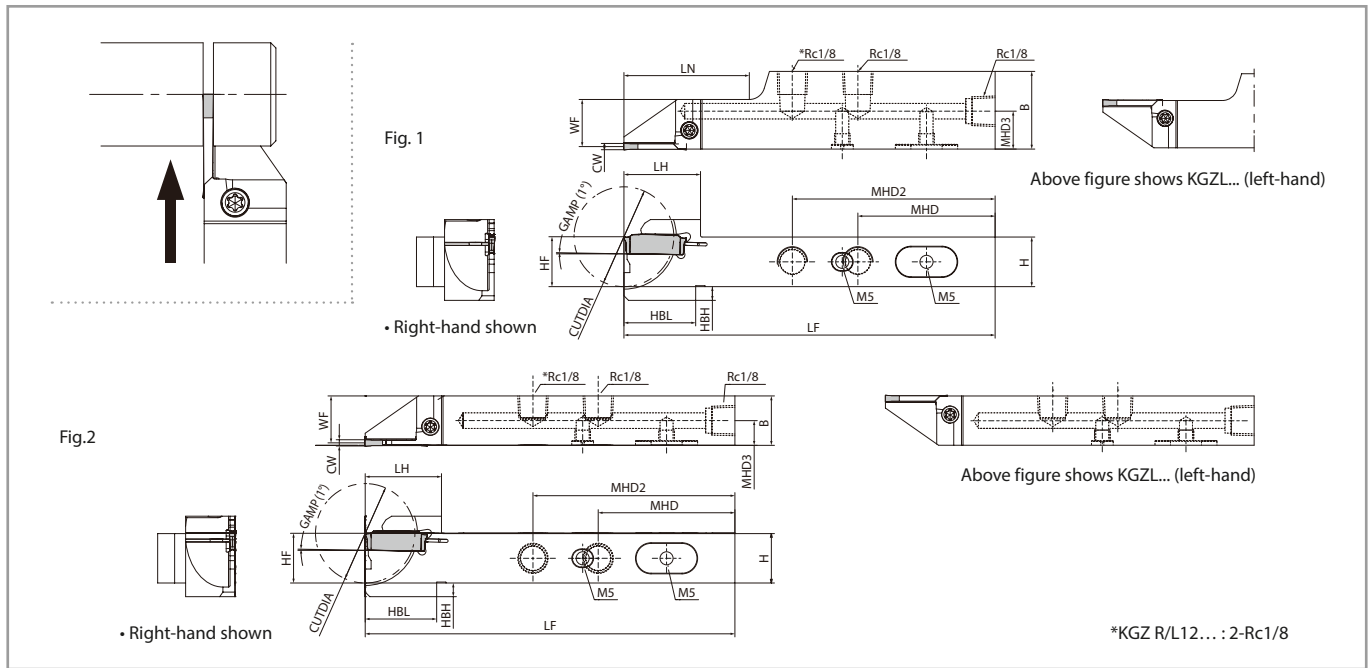

Description	Availability		Dimensions (mm)													Edge width CW (mm)		Shape	Spare parts				Applicable inserts
	R	L	CUTDIA	H	B	LH	MHD	MHD2	MHD3	HF	HBH	HBL	LF	LN	WF	MIN	MAX.		Plug 1	Plug 2	Clamp screw	Wrench	
KGZR 1218JX-2JCTM	●		24	12	18	19.8	54	-	8.4	12	8.5	19.8	120	43.7	11.2	2	3	Fig.1	GP-1	HSSX 4LP	SB-40120 TR	LTW-15S	GZG2020... GZM2020... GZMS2020... GZG2520... GZM2520... GZG3020... GZM3020... GZMS3020...
KGZL 1218JX-2JCTM		●							7.7														
KGZR 1625JX-2JCTM	●		32	16	25	24.8	44	65	12.2	16	4.5	23.2	120	40.0	15.2	2	3	Fig.1	GP-1	HSSX 4LP	SB-40120 TR	LTW-15S	GZG2020... GZM2020... GZMS2020... GZG2520... GZM2520... GZG3020... GZM3020... GZMS3020...
KGZL 1625JX-2JCTM		●							7.7														
KGZR 1218JX-2.4JCTM	●		24	12	18	19.8	54	-	8.4	12	8.5	19.8	120	43.7	11.0	2.4	3	Fig.1	GP-1	HSSX 4LP	SB-40120 TR	LTW-15S	GZG2520... GZM2520... GZG3020... GZM3020... GZMS3020...
KGZL 1218JX-2.4JCTM		●							7.7														
KGZR 1625JX-2.4JCTM	●		32	16	25	24.8	44	65	12.2	16	4.5	23.2	120	40.0	15.0	2.4	3	Fig.1	GP-1	HSSX 4LP	SB-40120 TR	LTW-15S	GZG2520... GZM2520... GZG3020... GZM3020... GZMS3020...
KGZL 1625JX-2.4JCTM		●							7.7														
KGZR 1218JX-3JCTM	●		24	12	18	19.8	54	-	8.6	12	8.5	19.8	120	43.7	10.8	3	3	Fig.1	GP-1	HSSX 4LP	SB-40120 TR	LTW-15S	GZG3020... GZM3020... GZMS3020...
KGZL 1218JX-3JCTM		●							7.7														
KGZR 1625JX-3JCTM	●		32	16	25	24.8	44	65	12.2	16	4.5	23.2	120	40.0	14.8	3	3	Fig.1	GP-1	HSSX 4LP	SB-40120 TR	LTW-15S	GZG3020... GZM3020... GZMS3020...
KGZL 1625JX-3JCTM		●							7.7														
KGZR 1212JX-2JCTM	●		24	12	12	19.8	59	-	6	12	6	19.8	120	11.2	2	3	Fig.2	GP-1	HSSX 4LP	SB-40120 TR	LTW-15S	GZG2020... GZM2020... GZMS2020... GZG2520... GZM2520... GZG3020... GZM3020... GZMS3020...	
KGZL 1212JX-2JCTM		●							6														
KGZR 1616JX-2JCTM	●		32	16	16	24.8	44	65	8	16	4.5	23.2	120	15.2	2.4	3	Fig.2	GP-1	HSSX 4LP	SB-40120 TR	LTW-15S	GZG2020... GZM2020... GZMS2020... GZG2520... GZM2520... GZG3020... GZM3020... GZMS3020...	
KGZL 1616JX-2JCTM		●							8														
KGZR 1212JX-2.4JCTM	●		24	12	12	19.8	59	-	6	12	6	19.8	120	11.0	2.4	3	Fig.2	GP-1	HSSX 4LP	SB-40120 TR	LTW-15S	GZG2520... GZM2520... GZG3020... GZM3020... GZMS3020...	
KGZL 1212JX-2.4JCTM		●							6														
KGZR 1616JX-2.4JCTM	●		32	16	16	24.8	44	65	8	16	4.5	23.2	120	15.0	2.4	3	Fig.2	GP-1	HSSX 4LP	SB-40120 TR	LTW-15S	GZG2520... GZM2520... GZG3020... GZM3020... GZMS3020...	
KGZL 1616JX-2.4JCTM		●							8														
KGZR 1212JX-3JCTM	●		24	12	12	19.8	59	-	6	12	6	19.8	120	10.8	3	3	Fig.2	GP-1	HSSX 4LP	SB-40120 TR	LTW-15S	GZG3020... GZM3020... GZMS3020...	
KGZL 1212JX-3JCTM		●							6														
KGZR 1616JX-3JCTM	●		32	16	16	24.8	44	65	8	16	4.5	23.2	120	14.8	3	3	Fig.2	GP-1	HSSX 4LP	SB-40120 TR	LTW-15S	GZG3020... GZM3020... GZMS3020...	
KGZL 1616JX-3JCTM		●							8														

Recommended tightening torque: 2.0 Nm / (SB-40120TR).

GM* and GD* inserts cannot be installed in the KGZ holder (GMM, GMG, GMN, GMR/L, GDM, GDG, GDGS, GDMS).

● : Available

Piping parts

Piping parts will be required separately if internal coolant is used

Pump pressure : Up to 20 MPa. Pump pressure: Up to 7.5 MPa if coupling is used.

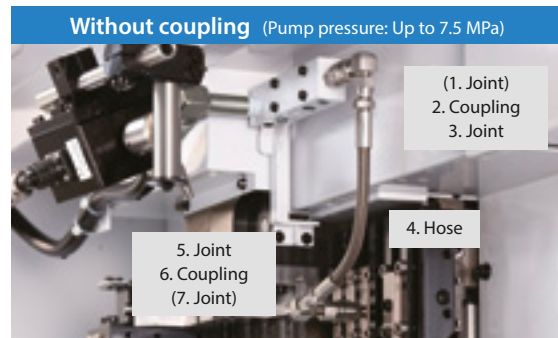
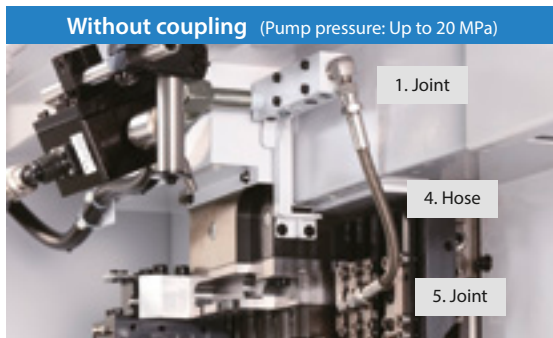

Combination part description (Example)

Spare parts	Description
1. Joint	J-AN-R1/8-G1/8
4. Hose	HS-G1/8-G1/8-200
5. Joint	J-AN-R1/8-G1/8

Convert the thread standards on the machine's side (Rc1/4, Rc1/8, NPT1/8, etc.) to the thread standard on the hose side (G1/8) for use.
Use sealing agents such as seal tapes when installing piping parts.

Combination part description (Example)

Spare parts	Description
(1. Joint)	-
2. Coupling	CP-ST-R1/8 • P-ST-RC1/8
3. Joint	J-AN-R1/8-G1/8
4. Hose	HS-G1/8-G1/8-200
5. Joint	J-AN-R1/8-G1/8
6. Coupling	P-ST-RC1/8 • CP-ST-R1/8
(7. Joint)	-

Convert the thread standards on the machine's side (Rc1/4, Rc1/8, NPT1/8, etc.) to thread standards of the coupling (Rc1/8, etc.) or hose (G1/8) for use.
Use sealing agents such as seal tapes when installing piping parts.

Piping part dimensions

Joint (1/3/5/7) Pressure: ~20.0 MPa

(Unit: mm)

Shape	Description	Availability	ød1	ød2	L	L1	L2	T1	T2
	J-ST-R1/4-G1/8	●	5.5	4.0	34	13	13	R1/4	G1/8
	J-ST-NPT1/8-G1/8	●	3.5	3.5	29	10	13	NPT1/8	G1/8
	J-ST-R1/8-G1/8	●	4.0	4.0	29	10	13	R1/8	G1/8
	J-AN-R1/8-G1/8	●	4.0	4.0	27	14	13	R1/8	G1/8
	J-ST-R1/4-RC1/8	●	-	-	17	12	-	R1/4	Rc1/8
	J-ST-NPT1/8-RC1/8	●	3.5	-	30	10	-	NPT1/8	Rc1/8
	J-ST-R1/8-RC1/8	●	3.5	-	33	13	-	R1/8	Rc1/8

Elbow piping (J-AN-R1/8-G1/8) is recommended.

●: Available

Coupling (2/6) Pressure: ~7.5 MPa

(Unit: mm)

Shape	Description	Availability
	CP-ST-R1/8	●
	P-ST-RC1/8	●

●: Available

Hose (4) Pressure: ~20.0 MPa

(Unit: mm)

Shape	Description	Availability	L
	HS-G1/8-G1/8-200	●	200
	HS-G1/8-G1/8-300	●	300
	HS-G1/8-G1/8-400	●	400
	HS-G1/8-G1/8-500	●	500
	HS-G1/8-G1/8-600	●	600
	HS-G1/8-G1/8-800	●	800

●: Available

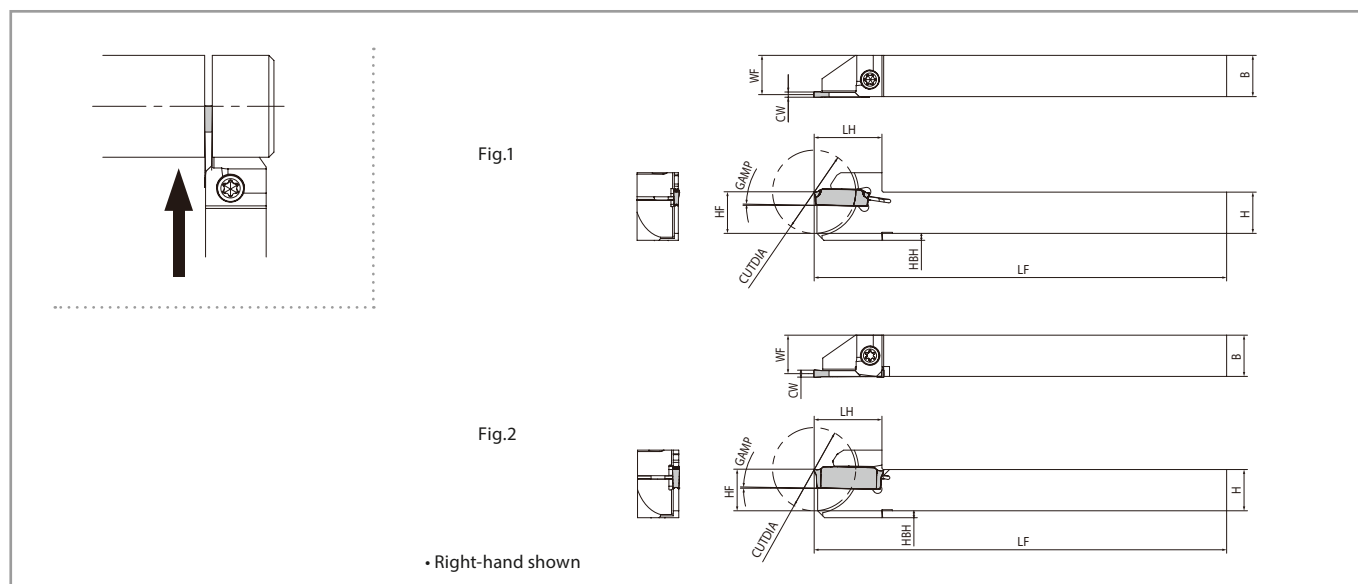

Description	Availability		Dimensions (mm)									Edge width CW (mm)		Angle	Shape	Spare parts		Applicable inserts						
	R	L	CUTDIA	H	B	LH	HF	HBH	LF	WF	MIN.	MAX.	GAMP	Clamp screw		Wrench								
KGZ ^{R/L} 1010JX-1.3D16	●	●	16	10	10	17.8	10	2.1	120	9.5	1.3	1.3	1°	Fig.1	SB-40120TR	LTW-15S	GZM1316...							
	●	●	20			18.7												85						
	●	●	16			17.8												120						
	●	●	12			12												12	85	11.5				
	●	●	24			19.8												120						
KGZ ^{R/L} 1010JX-1.5D16	●	●	16	10	10	17.8	10	2.1	120	9.4	1.5	1.5	1°	Fig.1	SB-40120TR	LTW-15S	GZM1516...							
	●	●	20			18.7												85						
	●	●	16			17.8												120						
	●	●	12			12												12	85	11.4				
	●	●	24			19.8												120						
KGZ ^{R/L} 1010JX-2	●	●	20	10	10	18.7	10	2.1	120	9.2	2	3	1°	Fig.1	SB-40120TR	LTW-15S	GZG2020... GZM2020... GZMS2020... GZG2520... GZM2520... GZG3020... GZM3020... GZMS3020...							
	●	●	24			12												12	19.8	12	85	11.2		
	●	●	32			16												16	24.8	16	120	15.2		
	●	●	2012K-2D34			20												12	26.8	20	-	11.2		
	●	●	2020K-2D34			34												20	20	-	125	19.2		
	●	●	2525K-2D34			25												25	32.7	25	-	24.2		
KGZ ^{R/L} 1010JX-2.4	●	●	20	10	10	18.7	10	2.1	120	9	2.4	3	1°	Fig.2	SB-40120TR	LTW-15S	GZG2520... GZM2520... GZG3020... GZM3020... GZMS3020...							
	●	●	24			12												12	19.8	12	85	11		
	●	●	32			16												16	24.6	16	120	15		
	●	●	2012K-2.4D34			20												12	26.6	20	-	11		
	●	●	2020K-2.4D34			34												20	20	-	125	19		
	●	●	2525K-2.4D34			25												25	32.7	25	-	24		
KGZ ^{R/L} 1212JX-3	●	●	24	12	12	19.8	12	2.1	120	10.8	3	3	1°	Fig.2	SB-40120TR	LTW-15S	GZG3020... GZM3020... GZMS3020...							
	●	●	32			16												16	24.6	16	120	14.8		
	●	●	38			19												13	28.6	19	125	11.8		
	●	●	42			20												12	30.7	20	-	120	10.8	
	●	●	51																35.2					
	●	●	42																30.7					18.8
	●	●	51																35.2					
	●	●	25			25												41.7	25	-	125	23.8		

Recommended tightening torque: 2.0Nm / (SB-40120TR) • 2.5Nm / (SE-50125TR) • 6.5Nm / (HH5X16).

●: Available

When machining large cutting dia. (over 36 mm) with KGZ^{R/L}...-3D38 or KGZ^{R/L}...-3D42, please follow the instructions below:

• Use 1-edge inserts

• Maximum workpiece diameter for 2-edge inserts is $\phi 36$

KGZ* and GD* inserts cannot be installed in the KGZ holder (GMM, GMG, GMN, GMR/L, GDM, GDG, GDGS, GDMS).

KGZS (For cut-off operation near sub spindle side)

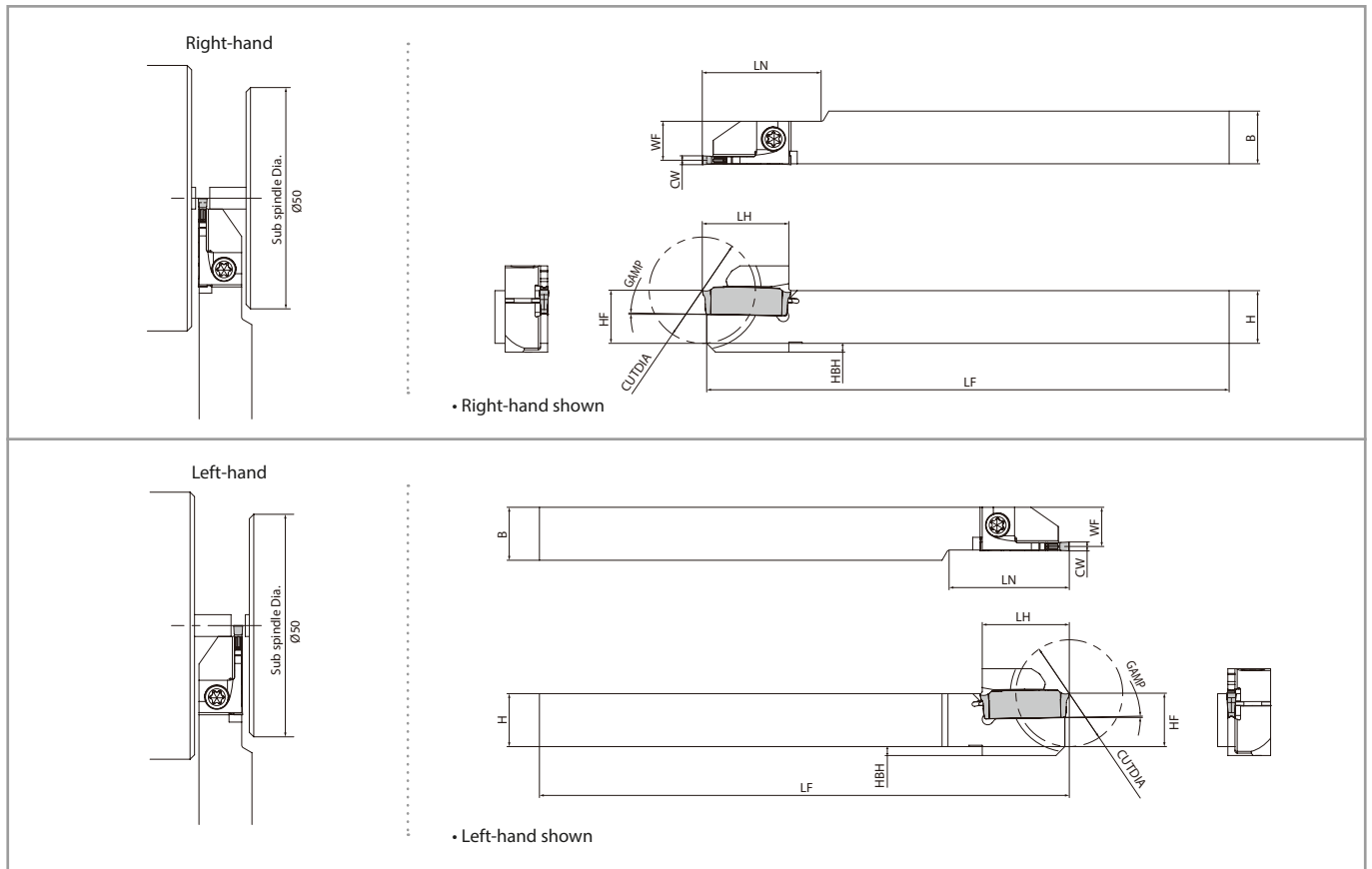

Description	Availability		Dimensions (mm)								Edge width CW (mm)		Angle GAMP	Spare parts		Applicable inserts				
	R	L	CUTDIA	H	B	LH	HF	HBH	LF	LN	WF	MIN.		MAX.	Clamp screw		Wrench			
KGZS ^{R/L} 1212F-1.3A	●	●	24	12	12	19.8	12	2.1	85	22	8.4	1.3	1.3	1°	SB-40120TR	LTW-15S	GZM1316...			
1212JX-1.3B	●	●							120	27										
1616JX-1.3B	●	●							16	-										
1212F-1.5A	●	●							85	22								8.4	1.5	1.5
1212JX-1.5B	●	●							120	27										
1616JX-1.5B	●	●							16	-								8.7	2	3
1212F-2A	●	●							85	22										
1212JX-2B	●	●							120	27								GZG2020..., GZM2020..., GZMS2020..., GZG2520..., GZM2520..., GZG3020..., GZM3020..., GZMS3020...		
1616JX-2B	●	●	16	-																

●: Available

Toolholder identification system

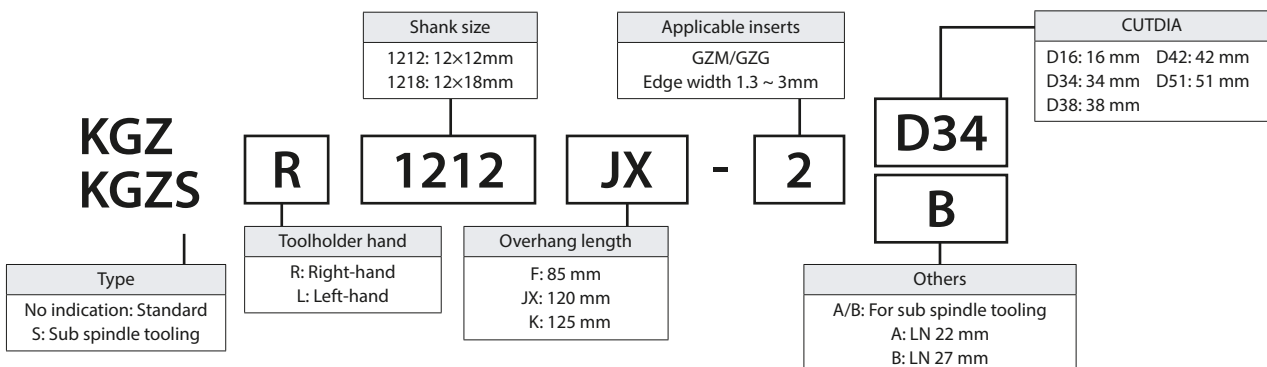

Precautions

Maximum Ap of the next tool (indicated as tool A) and holder interference

When using JCTM holder 1218/1212, note maximum Ap of the next tool to avoid interference.



Estimated maximum Ap of tool A (mm)

Workpiece dia.	ø12	ø16	ø20
JCTM description			
KGZ ^{R/L} 1218JX-*JCTM	2.4	2.0	1.7
KGZ ^{R/L} 1212JX-*JCTM	5.0	3.5	2.8

Piping part interference avoidance

Rectangular shank (KGZ^{R/L}1218..., KGZ^{R/L}1625...) are recommended for use with piping parts connected to JCTM holders.

When connecting piping parts to the JCTM square shank, check the lengths of A and B below to avoid interference with the screws of the tool turret.

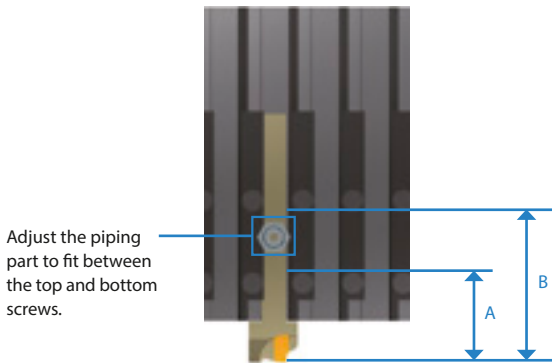

Shank size	Availability of square shank use
1212	"A" shorter than 51.5 mm and "B" longer than 68.5 mm → Available Other than the above conditions → Not available (Use a rectangular shank)
1616	Available

Compatibility with conventional tools

KGZ is not compatible with the conventional tools (KGD/KGM).

